



The connection to perfection

ECS UK
20 Speedwell Close
Huntington
Chester, CH3 6DX
United Kingdom
Tel.: +44 (0) 7440 202052
Email: uksales@ecs-electronics.com
www.ecs-electronicsuk.co.uk



The connection to perfection

ECS UK
20 Speedwell Close
Huntington
Chester, CH3 6DX
United Kingdom
Tel.: +44 (0) 7440 202052
Email: uksales@ecs-electronics.com
www.ecs-electronicsuk.co.uk



The connection to perfection

ECS UK
20 Speedwell Close
Huntington
Chester, CH3 6DX
United Kingdom
Tel.: +44 (0) 7440 202052
Email: uksales@ecs-electronics.com
www.ecs-electronicsuk.co.uk

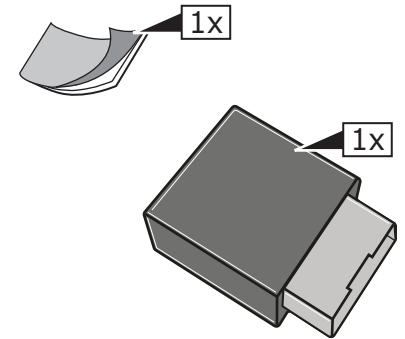
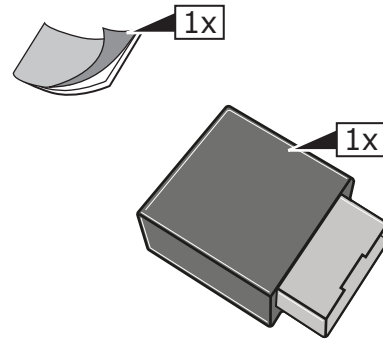
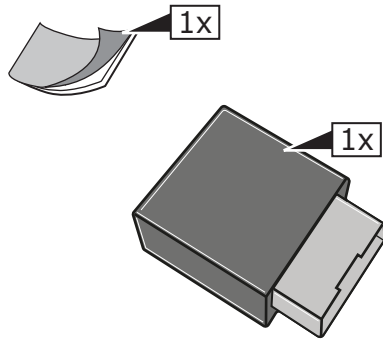

Module
5F022V0102SW0100

SP-595-ZZU

Module
5F022V0102SW0100

SP-595-ZZU

Module
5F022V0102SW0100

SP-595-ZZU